

Operating instructions

Excellent series

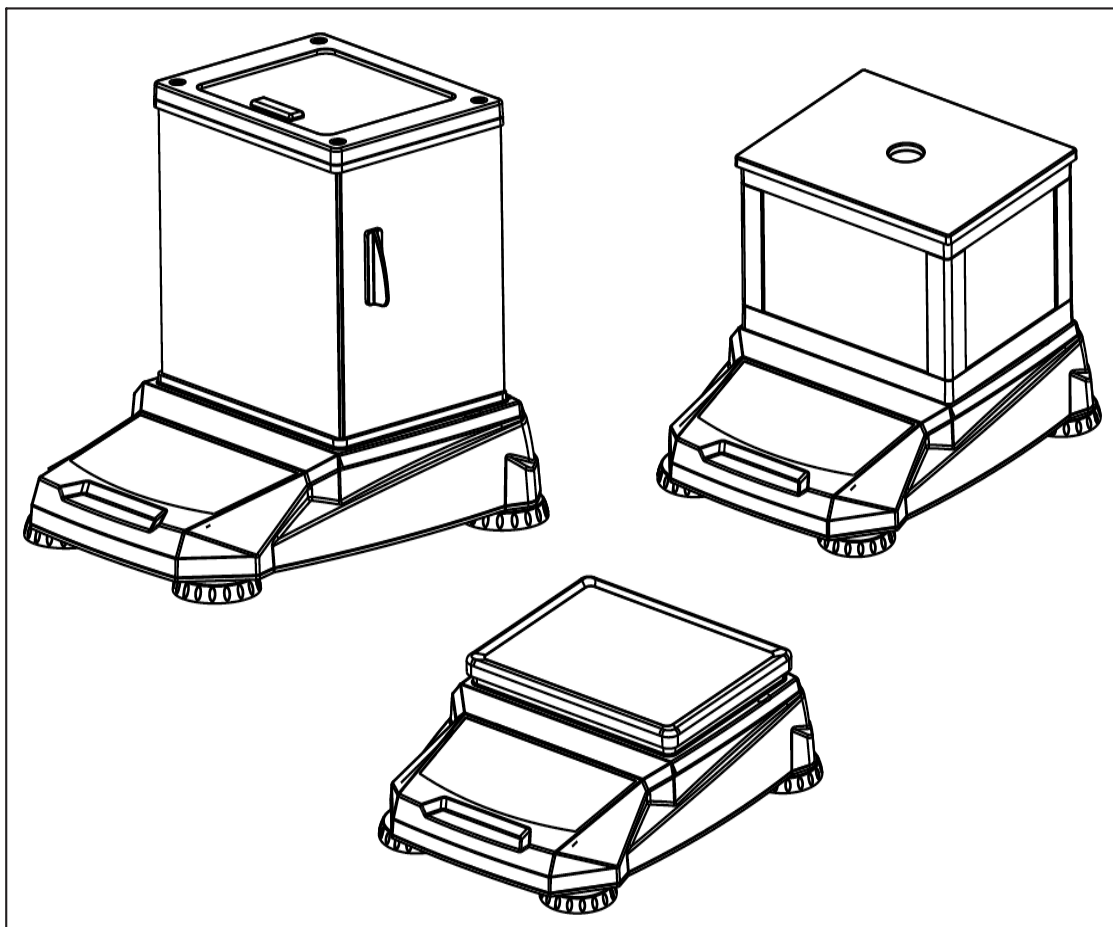

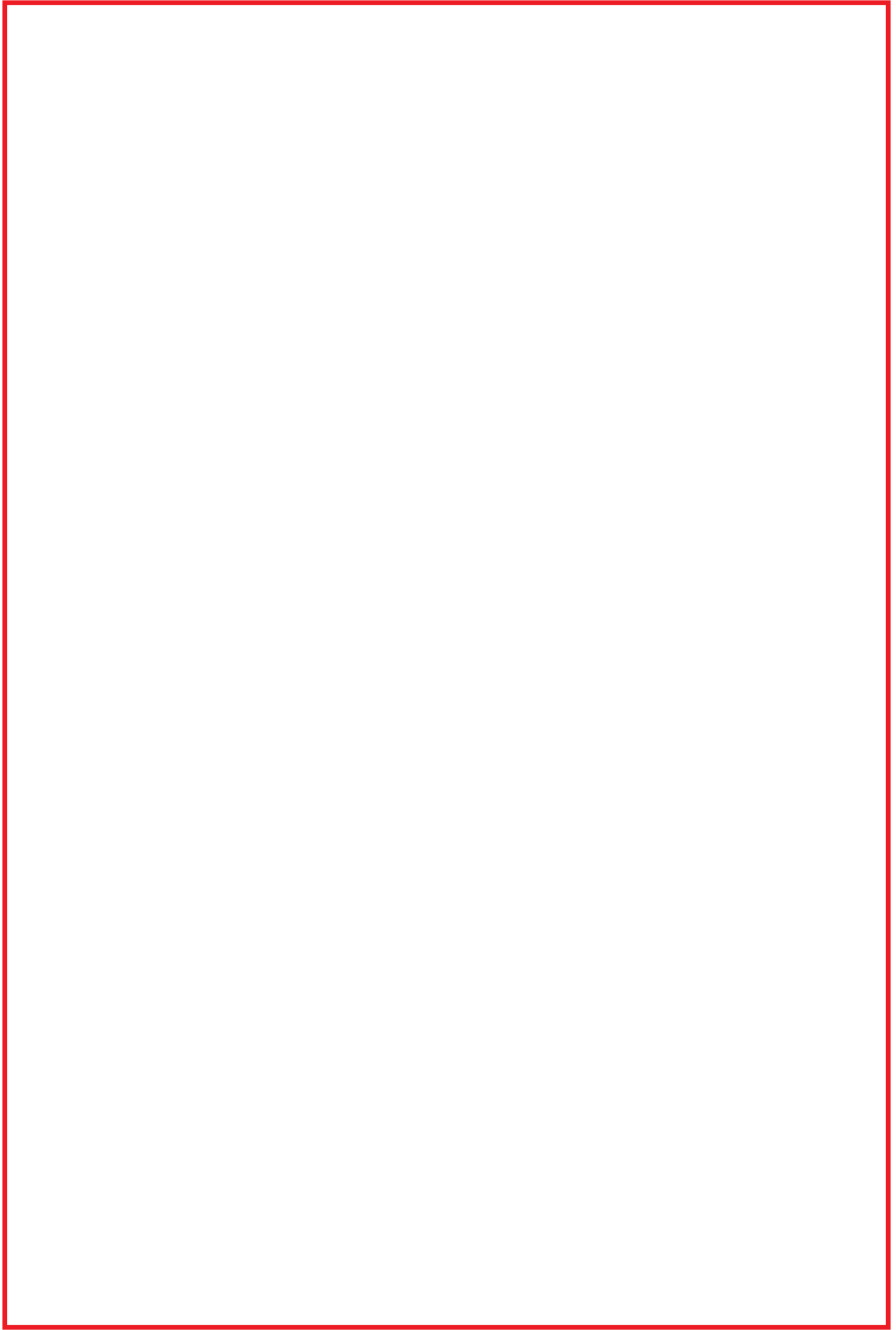

Contents

1. Introduction	3
1.1 Safety Prevention measures.....	3
1.2 Avoid Installing and using occasion	3
1.3 Product features.....	3
2. Install	
2.1 Install list.....	4
2.2 Accessories assembly process.....	5
2.2 TD-AS 03 series assembly.....	5
2.2.2TD-AS 02 series assembly.....	6
2.2.3TD-AS 01 series assembly.....	7
2.3 Adjust level.....	7
2.4 Connect to power.....	8
3. Operation panel and key functions	
3.1 Operation panel.....	8
3.2 Key functions definition.....	8
4. Operating instructions	9
4.1 Powerboot.....	9
4.2 Time setting.....	9
4.3 Initial calibration.....	9
4.4 Unit setting.....	9
4.4.1 Setup unit.....	9
4.4.2 Unit detail.....	10
4.5 Zero.....	10
4.6 Tare.....	10
4.7 Sample.....	10
5. RS232 Print setting	10
5.1 Setup RS232 print.....	10
5.2 Item setting.....	11
6. Normal fault and solving countermeasure	11
7. Technical instructions	11
7.1 Technical parameters.....	11
7.2 Product engineering drawing.....	12
7.3 Technical specification.....	13
8. Unit conversion	14

1.Introduction

1.1 Safety Precautions

Please use these Safety Precautions

- Verify that the AC Adapter input voltage matches the local AC power supply.
- Install and dismantle the balance, need to cut off the power
- Using the balance only in correct environment , work temperature 10°C-40°C
- Avoid strong wind and vibration
- Don't operate the balance in harmful environment
- Don't drop object to the scale
- Don't inversion the balance by tray or supporting
- Service should be performed only by authorized personnel.
- Before using the balance, should warm-up 20-30 minutes

1.2 Avoid Installing and using occasion

Assure that the stability and reliability, Please to avoid follow occasion:

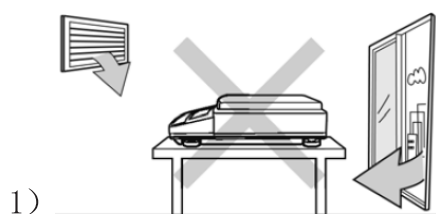

Avoid the gate with the wind
(air-condition, window)

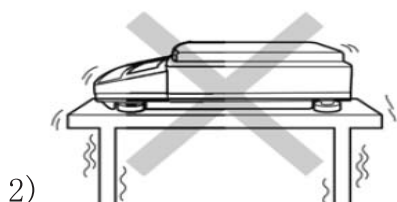

No vibration

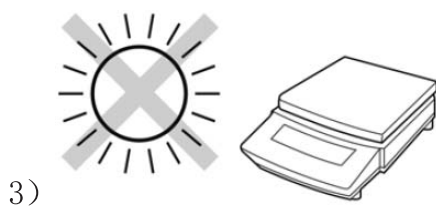

Avoid direct sunlight

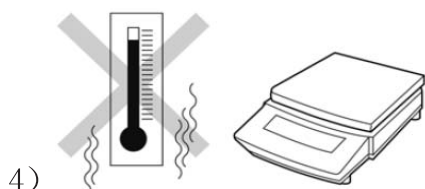

Avoid excessive temperature and humidity

1.3 Product features

- 1.Appearance style hale, fashion and brief, sporty powerful;
- 2.The body is made of PC alloy materials, hard and durably;
- 3.Scale is made of high quality stainless steel with SUS304, simply and fluency;
- 4.Large screen LCD display, backlight is soft and easy to read;

5. Humanization design, fast response;
6. With the features of easy counting weighing mode, easy to operate;
7. Equipped with the unit g, ct, oz etc. Total 21 kinds international unit;
8. Full range taring function;
9. Standard RS232 function, can connect with the printer, computer or others equipment;
10. AC/DC multiple function, rechargeable battery(option);
11. The windshield with pure white glass is used to ensure the stability of the weighing accuracy.

2. Install

2.1 Install list

Balance install list						
No.	Part	Specification	qty	TD-AS 03	TD-AS 02	TD-AS 01
1	Circular pan	Stainless steel 304, Ø118(mm)	1	●	□	-
2	Pan Support	PC alloy Ø117.2(mm)	1	●	□	-
3	M4 Hexagon screw	M4x8(flat cushion、spring washer)	1	●	●	-
4	glass(left Door)	Pure white glass(Include handle assembly)157.5x132x3.2(mm)	1	●	-	-
5	glass(right Door)	Pure white glass(Include handle assembly)157.5x132x3.2(mm)	1	●	-	-
6	glass(front Door)	Pure white glass 173.5x155.5x3.2(mm)	1	●	-	-
7	glass(back Door)	Pure white glass 163.5x155.5x3.2(mm)	1	●	-	-
8	glass(top Door)	Pure white glass(handle2) 136x131x3.2(mm)	1	●	-	-
9	Support pillar	Stainless steel Ø8x164(mm)	4	●	-	-
10	M4 Hexagon screw	Stainless steel M4x12	4	●	-	-
11	Top holder	PC alloy 179.4x139.4x8.5(mm)	1	●	-	-
12	Bottom holder	PC alloy 179.4x139.4x10.5(mm)	1	●	-	-
13	Square pan	Stainless steel 304, 145x115x7(mm)	1	-	□	-
14	Square pan support	PC alloy 144x114x15(mm)	1	-	□	-
15	Top,Bottom fixed base	PC alloy 188x148x15(mm)	2	-	□	-
16	L type support	PC alloy 91x20x20(mm)	4	-	□	-
17	cover	PC alloy 193x153x6(mm)	1	-	□	-
18	PMMA(left, right)	117x90.5x2(mm)	2	-	□	-
19	PMMA(font,back)	157x90.5x2(mm)	2	-	□	-
20	Large square pan	Stainless steel 304, 188x148x11(mm)	1	-	-	●
21	Large square pan support	PC alloy 186.9x146.9x24(mm)	1	-	-	●
22	M5 Hexagon screw	M5x10(Include flat washer, spring washer)	2	-	-	●

Note: Please check accessories according to product type, “●”means have, “-”means none, “□” is option

2.2 Accessories assembly Process

2.2.1TD-AS 03 series assembly procedure(with glass windshield)

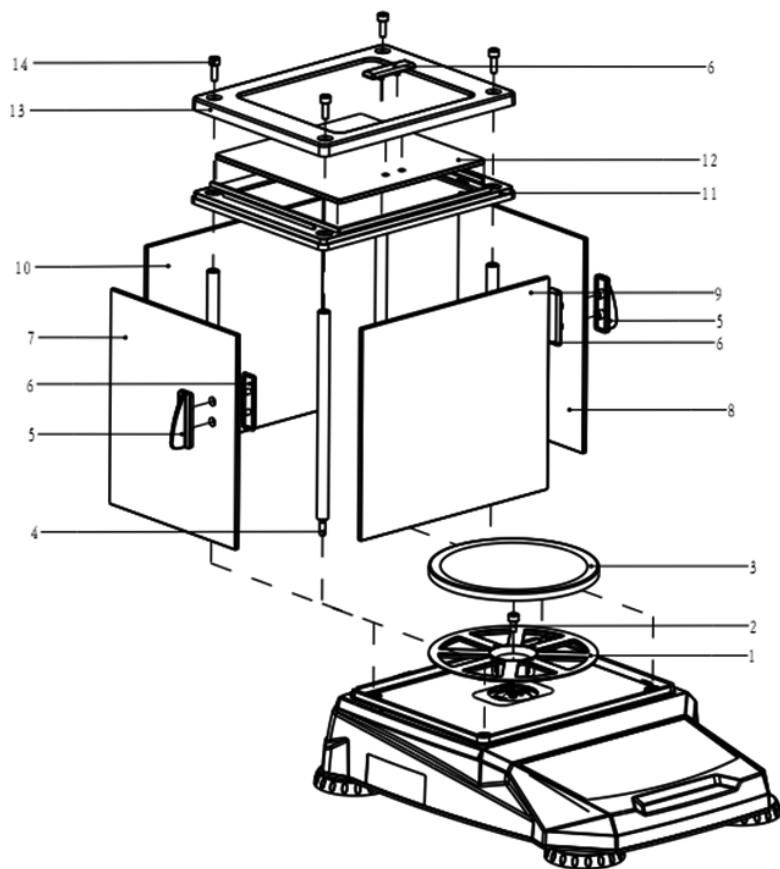

- 1.Circle tray support
- 2.M4x8 screw(include flat washer, spring washer)
- 3.Stainless steel tray
- 4.Support pillar(Qty:4)
- 5.Handle1(Qty:2)
- 6.Handle2(Qty:3)
- 7.Left glass
- 8.Right glass
- 9.Front glass
- 10.Back glass
- 11.Bottom fix frame
- 12.Top glass
- 13.Top fix frame
- 14.M4x12 screw(Qty:4)

Install process:

1) Tightening circle tray support



2 Put down circle tray



3) Screwing stainless steel support pillar



4) Insert glass fully into Frame(left, right, front, back),Pay attention to the handle set direction as follow picture show:



a

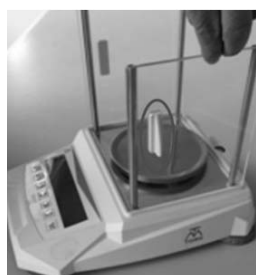

b



c



d

5) Cover bottom fix frame, make sure the glass edge and support pillar end into the slot of frame.



6) Put top glass into door

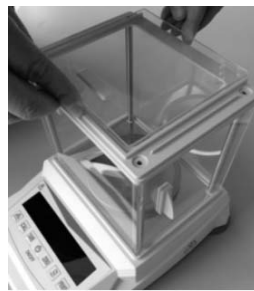

7) Put top frame down, Tightening screws

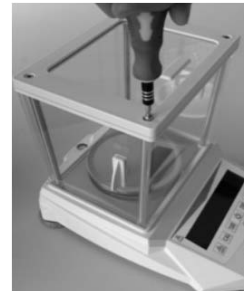

2.2.2TD-AS 02 series assbmly procedure (simple windshield)

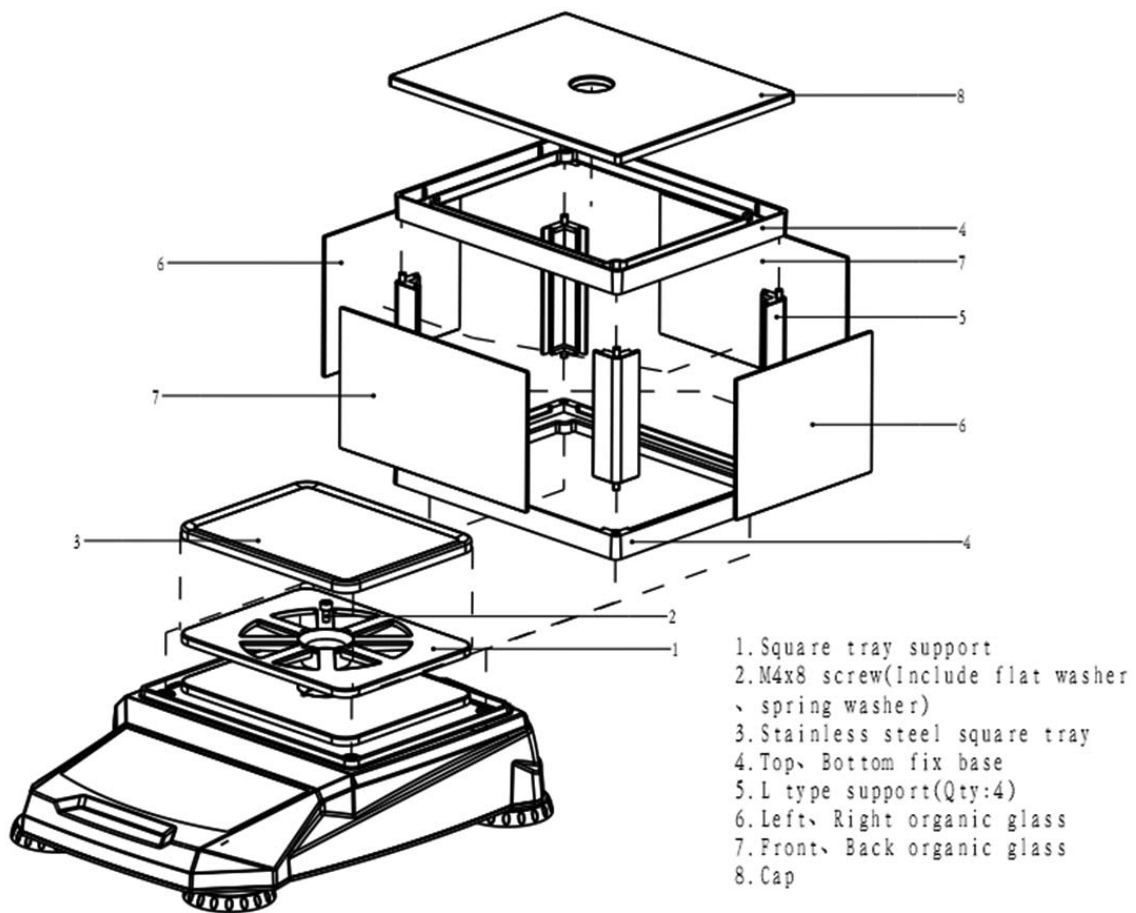

Install process:

1) Tightening square tray support



2) Put down square tray



3) Install L type support to fix frame

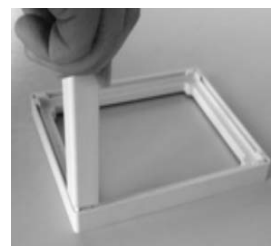

4) Install organic glass into the groove (left& right, front& back)

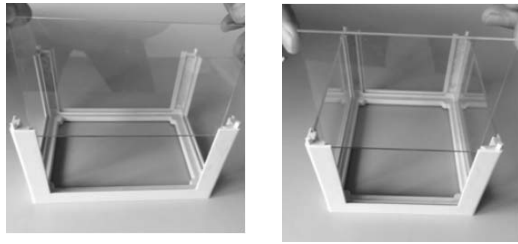

5) Press the top fix frame



6) Put down the cap



7) Put the simple windshield on the balance

2.2.3 TD-AS 01 series assembly procedure

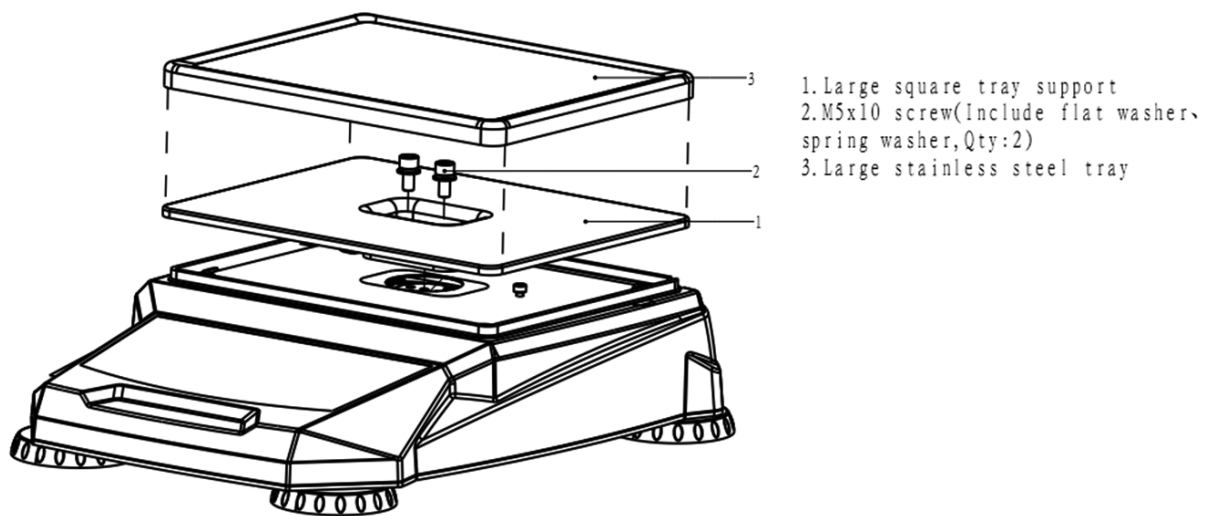

Install process:

- 1) Tightening large square support (using cross screwdriver)
- 2) Put down large square tray

2.3 Adjust level

Level the balance on a stable desk. When the bubble is in the center of the circle, balance is leveled. Avoid locations with excessive air current, vibrations, heat sources or rapid temperature changes. As follow picture:

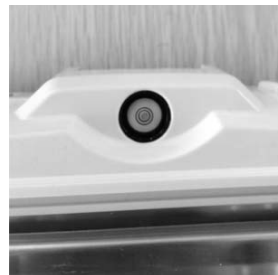

2.4 Connect to power

Power adapter one end is connected to balance, the other end to AC base







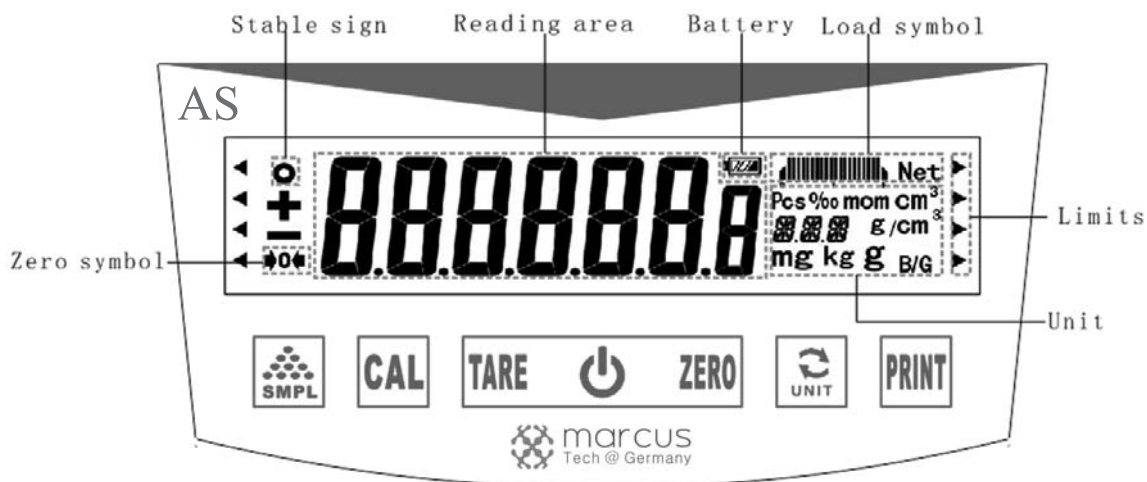

3. Operation panel and key functions definition

3.1 Operation panel introduction





3.2 Key definition

Key	Operation	Function description
	Short press	In the mode of PCS/%/% / BG to operate
	Long press 3s	Initiates Span Calibration by long press 3s
	Short press	Tare the weighing
	Short press	Turns balance on/off,
	Short press	sets display to zero
	Short press	Steps through active units and modes
	Short press	Sends data











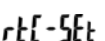
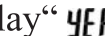





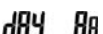

4. Operating instructions

4.1 Powerboot

Short press  on/off switch, LCD、EL、LED all light,

Screen display about 1.5s, as follow:  ,Then screen display from 9999999 to 1111111, with beeper, need on 600ms, Off 400ms, then display “version”,“model”, finally LCD show: 





4.2 Time setting

- 1) On the opening state, press  3sec, enter the user setting, LCD display:  (RTC-SET), then display“ ”, press  set Years, press  change digital position to set years, press  confirm;
- 2) LCD jump to set Months, display “ ”, press set months, press  change digital position to set months, press  confirm;
- 3) LCD jump to set Days, display“ ”, press  set days, press  change digital position to set days, press  confirm;
- 4) LCD jump to set hours, display“ ”, press  set hours, press  change digital position to set hours, press  confirm;
- 5) LCD jump to set minutes, display“ ”, press  set minutes, press  change digital position to set minutes, press  confirm, finish the time setting.

4.3 Initial calibration







To assure the balance accuracy, The first time to using the balance, must to do calibration, This product calibration with external, Before calibration, it need to adjust the balance level.

Calibration as follow:

- 1) Press  to open balance , firstly warm-up 20-30 minutes;
- 2) Calibration, press  3sec, LCD display“ ”, waiting for a sign “ - - - - - ”, then LCD display twinkling numerical data (Remark: press  can change different corresponding weights), At this time, put down the corresponding weight, then waiting for a sign again“ - - - - - ”, then LCD display corresponding weight, when LCD display “ ”, remove weight, LCD display 0, completed calibration.

4.4 Unit setting

4.4.1 Set unit

- 1) Started balance, long press  3sec, enter the user settings, LCD display “ ” (UNITSET), then LCD display“ ”;
- 3) Then press  changing weighing unit, if confirm, press  to confirm. When changing weighing unit, can press  to close or open the unit, after setting the unit, press  to confirm.

4.4.2 Unit detail

- | | |
|---------------------------------|-------------------------|
| 1) g | 12) H.tl HONG KONG TAEI |
| 2) ct MET.CARAT | 13) S.tl SINGAPORE TAEI |
| 3) lb AVORIRDUPOIS POUND | 14) t TOLA |
| 4) oz AVORIRDUPOIS OUNCE | 15) M Mesghai |
| 5) ozt TROY OUNCE | 16) cl Tical |
| 6) dr AVOIRDUPOIS DRAM | 17) PCS |
| 7) GN GRAIN | 18) % |
| 8) dwt PENNY WEIGHT | 19) ‰ |
| 9) mom MOMME | 20) B/G |
| 10) K.tl HONG KONG JEWELRY TAEI | 21) Kg |
| 11) T.tl TAEI (TWN) | |

4.5 Zero

No load on the balance, short press **ZERO**, LCD firstly display “**ZERO**” (ZERO), then display 0, Zero effect is inside of the maximum 4%

4.6 Taring

When there is a load on the balance, short press **TARE**, LCD firstly display “**TARE**” (TARE), then display 0, Have the full range taring function.

4.7 Sample

- 1) On the opening state, At the mode of PCS, %, ‰ to sample, short press **SMPL**, LCD display “**5- 5**”, short press **ZERO**, chose numerical data, place specific objects, press **SMPL**, then load-off the objects, finish sampling
- 2) On the opening state, At the mode of B/G unit, short press **SMPL**, into B/G mode, LCD display proportion value “**000000**”, press **ZERO** to set numerical data, press **TARE** to change the digital position, after setting proportional value, press **SMPL** to confirm.

5. RS232 print setting

5.1 RS232 print set

- 1) Connect RS232 to the adaptor, Analysis weighing data, through RS232 sending out. Press **PRINT** 3sec, enter the user settings, LCD display “**rs--set**” (rs—set), then LCD display **000000** ;
- 2) Press **ZERO** to set numerical data, press **TARE** to change the digital position. According to the definition about (a), (b), (c), (d), (e), (f), (g) to setting. after setting, press **SMPL** to confirm.
(a), (b), (c), (d), (e), (f), (g) definition:

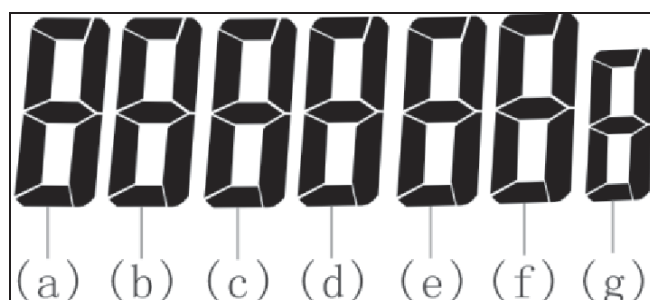

- (a) 0=9600 1=19200
- (b) 0=continuous output 1=stable output 2=press  output
- (c) 0=none 1=output date
- (d) 0=none 1=output ITEM
- (e) 0=PC work 1=print by tag paper 2=print by continuous paper 3=Micro printer
- (f) 0
- (g) 0

5.2 Item setting

Item setting can make for managing product number, clause, logo or print data.

Setting as follow:

1) On the opening state, long press  3s, LCD display ~~1234567~~ (ITEMSET), leave  , LCD display ~~1234567~~;

2) Press  to set numerical data, press  to change the digital position, set by user, press  to confirm.

6. Normal fault and solving countermeasure

Error information	Reasons analysis	Solution
Can't turn on	No power	Check adaptor connect or battery voltage is ok ?
Reading not correct	No calibration balance by right way Work environment not stable	calibration balance Put the balance by stable
Can't calibration the balance	No calibration balance by right way Work environment not stable	calibration balance Put the balance by stable
Auto turn off	Battery voltage too low (only cell supply power)	charge
OVER	Check the weighing (if over the max capacity 9e)	Check the weighing Check the pan whether interference with the limit screw or support block

7. Technical Instructions

7.1 Technical data

Working Temperature: 10°C -40°C

Working Voltage: DC12V

Working humidity range: 40%-85%

Adaptor data: Input: AC100-240V 50/60Hz 0.3A, Output: DC12V 1000mA

7.2 Product engineering drawings
EX series outline dimension, unit: mm

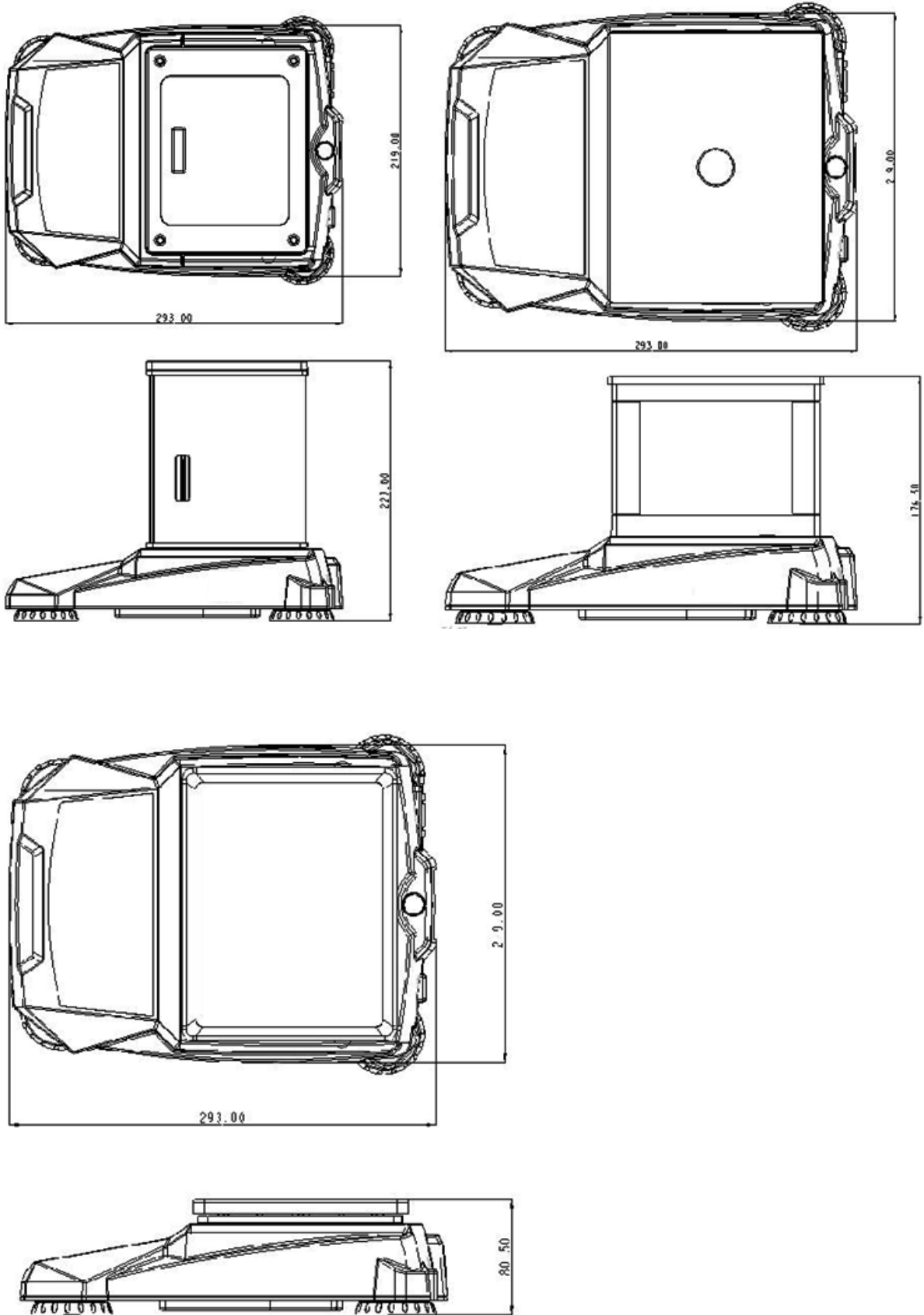

7.3 Specification

Item No.	TD-AS 103H	TD-AS 203H	TD-AS 303H
Capacity(g)	100	200	300
Readability(g)	0.001		
Repeatability(g)	±0.001		
Linearity(g)	±0.002		
Working Temperature(°C)	10-40		
working voltage	DC12V		
CAL	External calibration (weights option)		
RS232 (connector)	have		
Warm-up time(min)	20-30		
Frame Size(LxWxH)(mm)	292x218x227		
Packing Size(LxWxH)(mm)	400x300x200		
Pan Size(mm)	Ø118		
Effective Height(mm)	145		
Weight(kg)	3.1		
Leveling	have		

Item No.	TD-AS 302S	TD-AS 602S	TD-AS1502S	TD-AS2002S
Capacity(g)	300	600	1500	2000
Readability(g)	0.01			
Repeatability(g)	±0.01			
Linearity(g)	±0.02			
Working Temperature(°C)	10-40			
working voltage	DC12V			
CAL	External calibration (weights option)			
RS232 (connector)	have			
Warm-up time(min)	20-30			
Frame Size(LxWxH)(mm)	292x218x227			
Packing Size(LxWxH)(mm)	400x300x200			
Pan Size(mm)	Ø118			
Effective Height(mm)	95~185			
Weight(kg)	3.1			
Leveling	have			

Item No.	TD-AS 2002	TD-AS 3002	TD-AS 5002	TD-AS 3001	TD-AS 6001
Capacity(g)	2000	3000	5000	3000	6000
Readability(g)	0.01			0.1	
Repeatability(g)	±0.01			±0.1	
Linearity(g)	±0.02			±0.1	
Working Temperature(°C)	10-40				
working voltage	DC12V				
CAL	External calibration (weights option)				
RS232 (connector)	have				
Warm-up time(min)	20-30				
Frame Size(LxWxH)(mm)	292x218x80				
Packing Size(LxWxH)(mm)	400x300x200				
Pan Size(mm)	188x148x11				
Effective Height(mm)	185				
Weight(kg)	2.8				
Leveling	have				

8. Unit conversion

No.	Unit	Symbol	Conversion(g)
1	gram	g	1
2	MET.CARAT	ct	0.1999694g
3	AVORIRDUPOIS POUND	lb	453.59237g
4	AVORIRDUPOIS OUNCE	oz	28.349523125g
5	TROY OUNCE	ozt	31.1034768g
6	AVOIRDUPOIS DRAM	dr	1.7718451g
7	GRAIN	GN	0.06479891g
8	PENNY WEIGHT	dwt	1.55517384g
9	MOMME	mom	3.749996g
10	HONG KONG JEWELRY TAEI	K.tl	37.4290018g
11	TAIWAN TAEI	T.tl	37.49995g
12	HONG KONG TAEI	H.tl	37.799375g
13	SINGAPORE TAEI	S.tl	37.799366256g
14	TOLA	t	11.6638038g
15	Mesghai	M	4.6083162g
16	Tical	cl	16.3293g
17		kg	1000g
18		B/G	
19		PCS	
20		%	
21		‰	

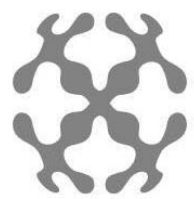

marcus
Tech @ Germany